

AHD

BRIGADE®

VBV-770HM vehicle CCTV monitor

Quick installation guide

Guide d'installation rapide

Kurzanleitung

Guida d'installazione rapida

Guía rápida de instalación

Snelle installatie handleiding

Guia rápida de instalação

Руководство по быстрой установке

Hızlı Montaj Klavuzu

Skrócona instrukcja instalacji

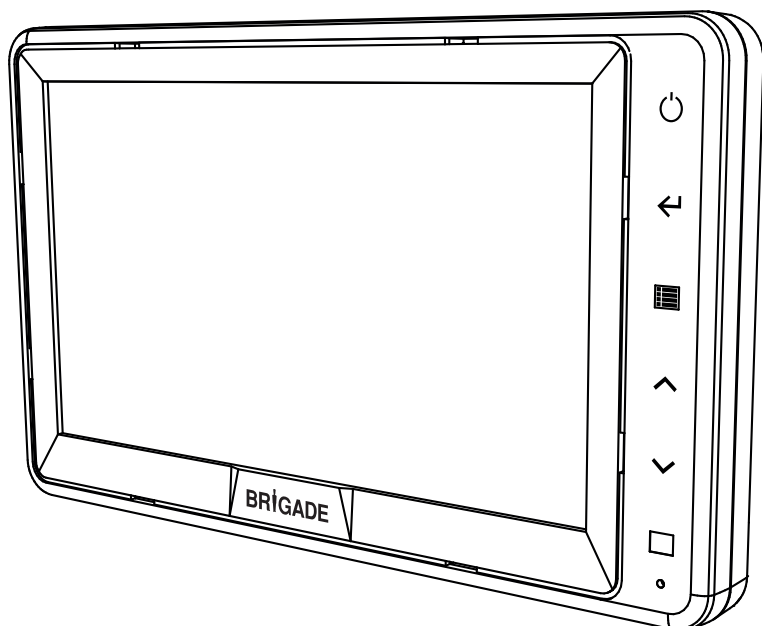

1 Contents

Contenu/Inhalt/Contenuto/Contenido/Inhoud/Conteúdo/Содержание/İçerik
/zawartość

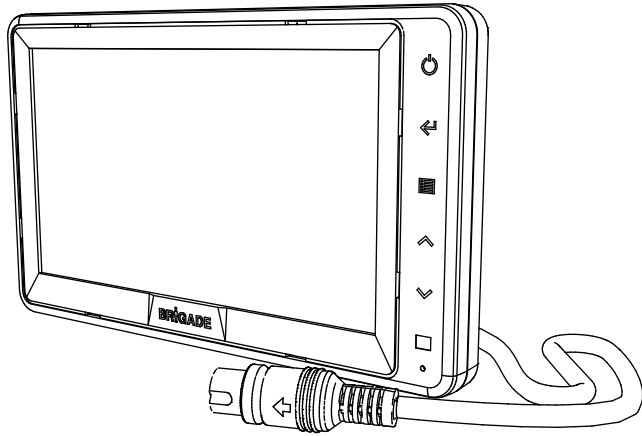

VBV-770HM-M

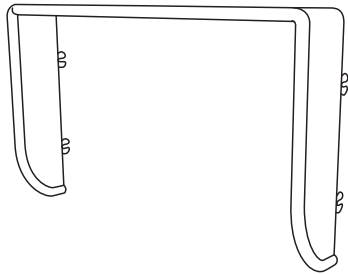

VBV-770M-SS

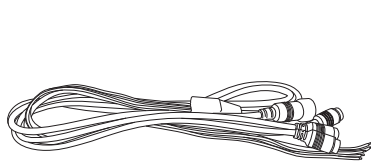

VBV-7X0M-CA

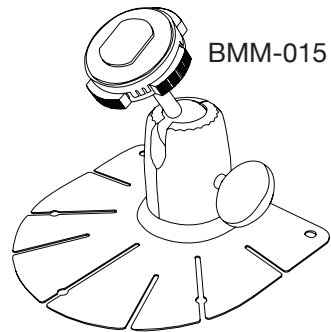

BMM-015

2 Monitor installation

Surveiller l'installation/Monitor-Einbau/Installazione del monitor/
Instalación del monitor/Monitor installatie/Instalação do monitor/
Расположение камеры/Monitor Montaji/Instalacja monitora

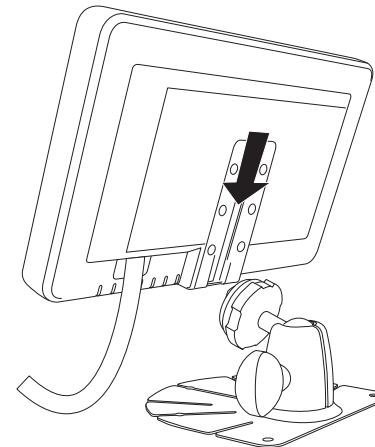
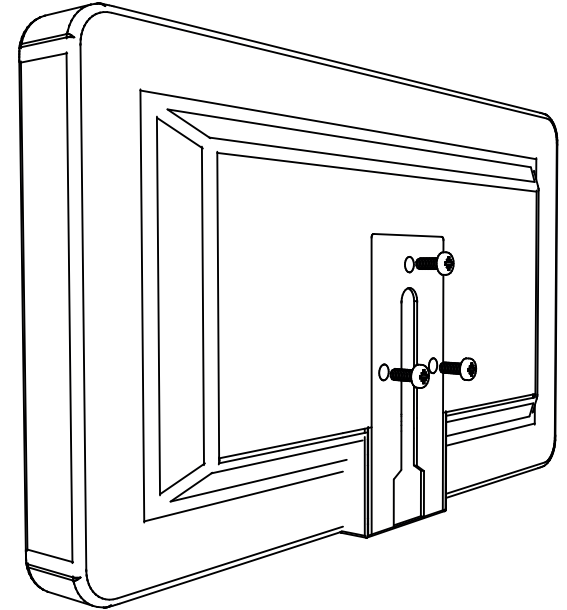
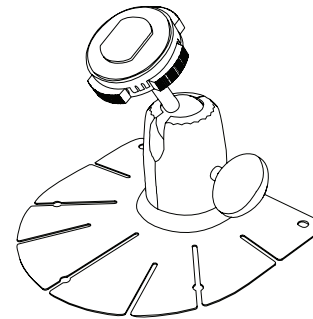
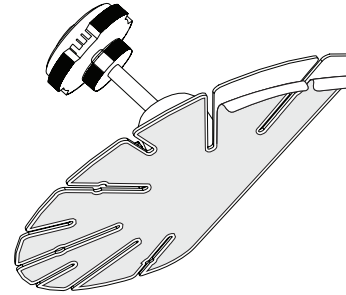

M4 x 8mm

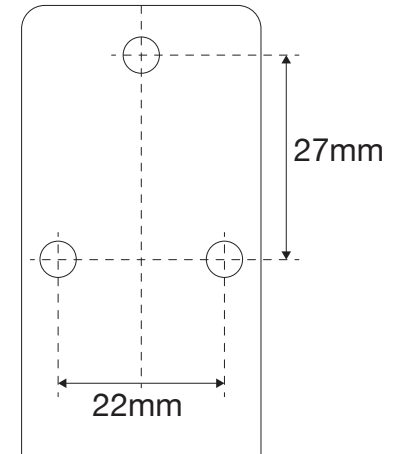

3 Connections

Connexions/Anschlüsse/Connessioni/Conexiones/Aansluitingen/Conexão/
Сигнал скорости/Bağlantılar/Podłączenia

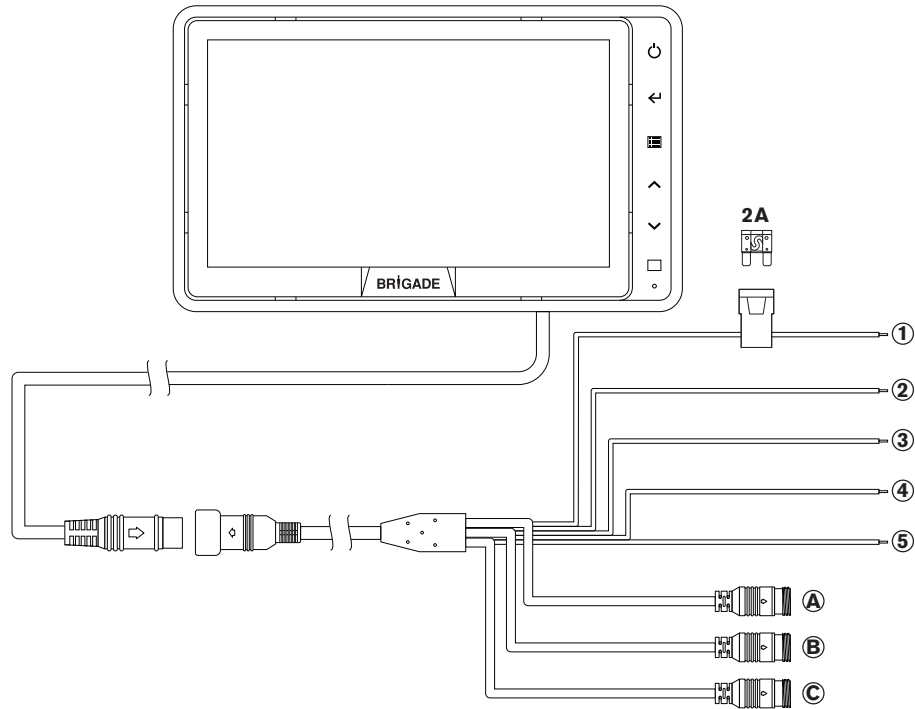

Red Power	Black Ground
Rouge Positif	Noir Masse
Rot Betriebsspannung	Schwarz Masse
Rosso Positivo	Nero Massa
Rojo Positivo	Negro Masa
Rood Vermogen	Zwart Grond
Vermelho Positivo	Preto Massa
красный мощность	черный заземление
Kırmızı Arti	Siyah Eksi
Czerwony Zasilanie	Czarny Masa

Trigger	White	Blue	Brown
Déclencher	Blanc	Bleu	Brun
Trigger	Weiss	Blau	Braun
Attivare	Bianco	Blu	Marrone
Desencadenar	Blanco	Azul	Marrón
Trekker	Wit	Blauw	Bruin
Gatilho	Branco	Azul	Marrom
триггер	белый	синий	коричневый
Tetik	Be Yaz	Mavi	kahverengi
Włacznik	Biały	Niebieski	Brązowy

Camera	Camera	Camera
Caméra	Caméra	Caméra
Kamera	Kamera	Kamera
Telecamera	Telecamera	Telecamera
Cámara	Cámara	Cámara
Camera	Camera	Camera
Câmera	Camera	Camera
камера	камера	камера
kamera	camera	camera
Kamera	Kamera	Kamera

4 Controls

Contrôles/Bedienung/Controlli/Controles/Controles/Controles/контроля/
Kumandalar/Sterowanie

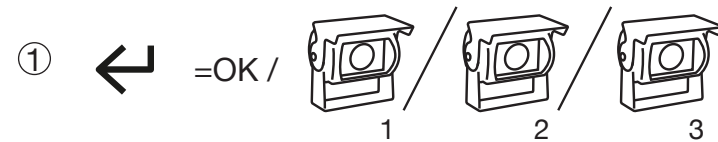
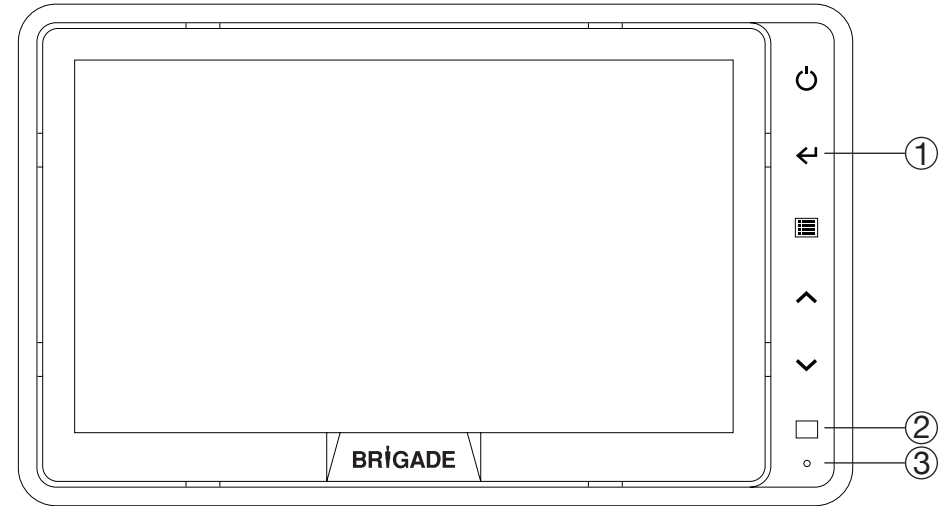

- ② Remote control receiver
Récepteur de la télécommande
Empfänger für Fernbedienung
Ricevitore per telecomando
Receptor de control remoto
Afstandsbediening ontvanger
Receptor de controle remoto
Приемник дистанционного управления
Uzaktan Kumanda Algılayıcısı
Czujnik pilota

- ③ Automatic low light sensor
Capteur optique automatique de basse luminosité
Licht Sensor
Sensore automatico di bassa luminosità
Sensor automático de baja luminosidad
Automatische lage lichtsensor
Sensor de luz baixa automática
Автоматический датчик низкой освещенности
Düşük Işık Sensörü
Automatyczny czujnik światła

5 Operation

Opération/Betrieb/Operazione/Operación/Werking/Operação/операция/ Çalıştırma/ Użytkowanie

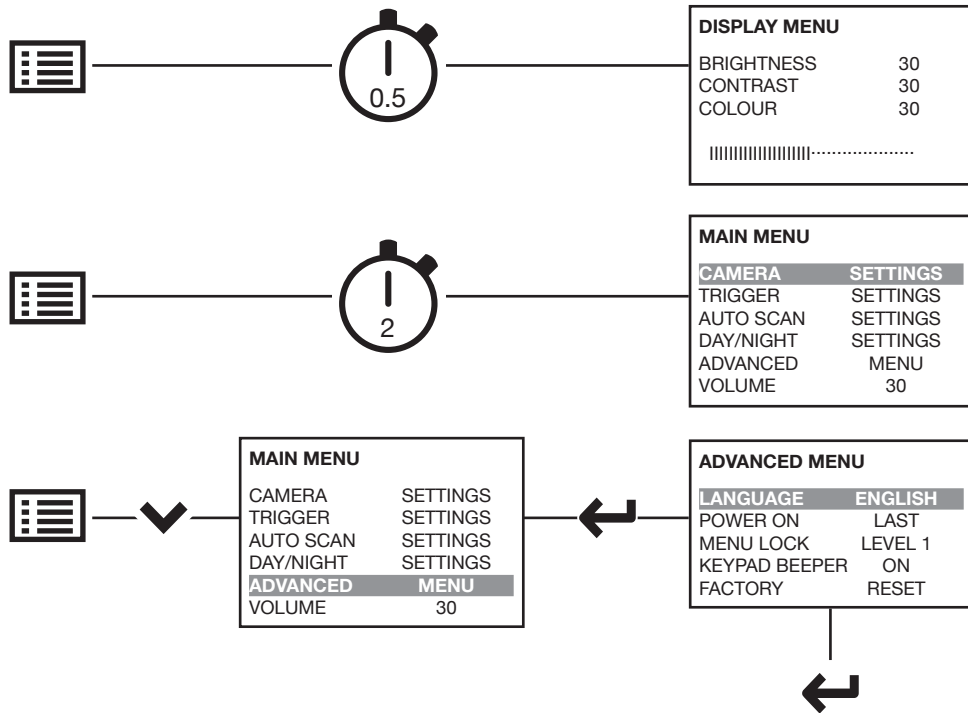

Trigger setting

Paramètre de déclenchement/Trigger-Einstellung/Impostazione trigger/ Configuración de disparadores/Drempelwaarde/Configuração de acionadores/ настройки пускового/Tetik ayarları/Ustawienia włącznika

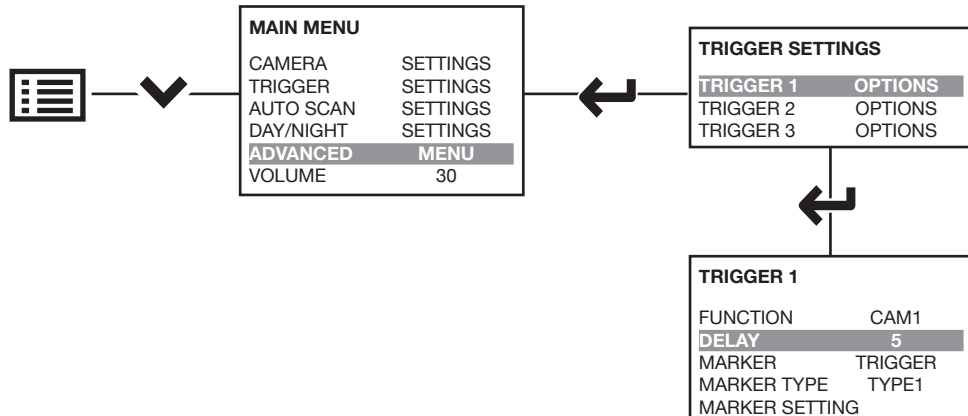

5 Operation

Opération/Betrieb/Operazione/Operación/Werking/Operação/операция/ Çalıştırma/ Użytkowanie

Button lock

Bouton de verrouillage/Tastensperre/Blocco dei Pulsanti/Bloqueo de botones/ Кнопка закрывания/ Bloqueio dos botões/кнопка блокировки/Düğme kilidi/ Przycisk blokady

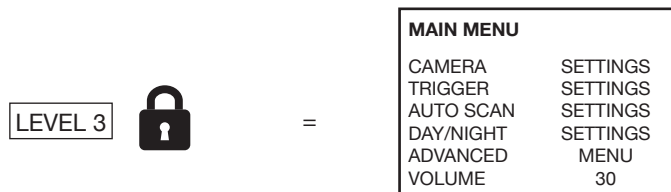
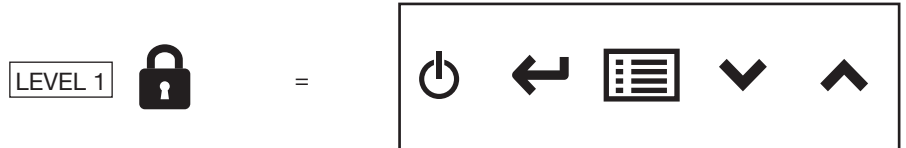
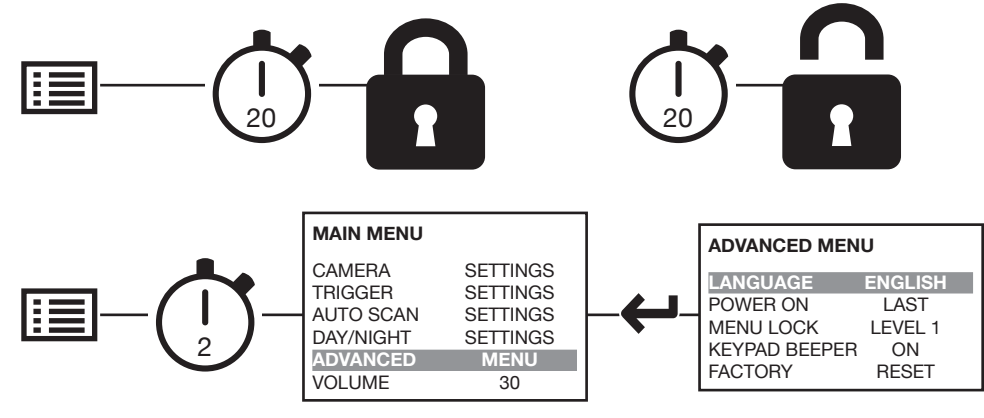

5 Operation

Opération/Betrieb/Operazione/Operación/Werking/Operação/операция/ Çalıştırma/ Użytkowanie

Marker setting

Mise en marqueur/Einstellung der Markierungen/Impostazione dei marcatori/ Ajuste de los marcadores/Marker instelling/Definir os marcadores/установкой бита/ İşaretleyici Ayarı/Ustawienia znacznika

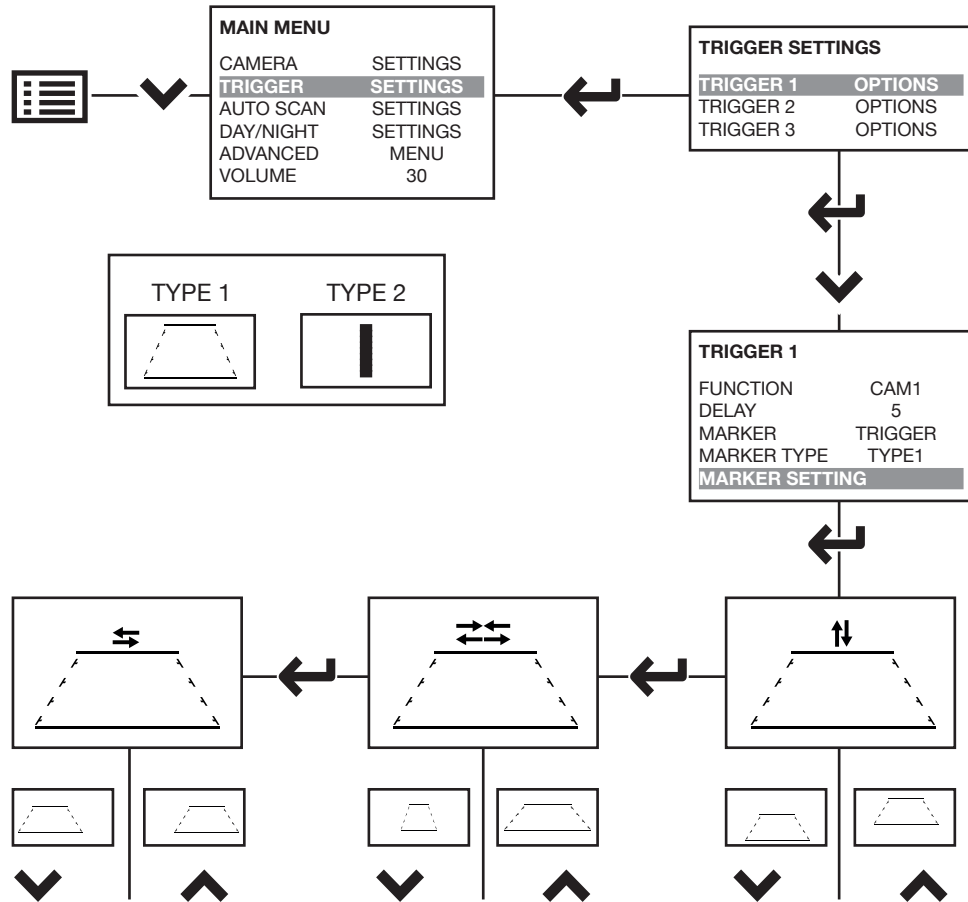

6 Specifications

Spécifications/Spesifikationen/Specifiche/Especificaciones/Specificaties/ Especificações/Спецификация/Özellikler/Спецификація

EN Specifications	
Monitor	VBV-770HM
TV system	CVBS-NTSC/PAL AHD 1.0-720p/AHD 2.0-1080p (auto detect)
Picture	7" TFT LCD colour monitor with on-screen display function
Display size	7" diagonal
Field of view	Top: 85°, Bottom: 85°, Left: 85°, Right: 85°
Resolution	1024x3(RGB)x600
Picture image	Normal - Mirrored via OSD
Power	12/24Vdc input
Inputs	3 x camera
Dimensions	195.5(w) x 117.5(h) x 25.5(d)mm 7.6(w) x 4.6(h) x 1(d) inches
Operating temperature	-30°C ~ +70°C -22°F ~ +158°F

FR Specifications	
Moniteur	VBV-770HM
Système TV	CVBS-NTSC/PAL AHD 1.0-720p/AHD 2.0-1080p (Détection automatique)
Image	7" TFT LCD moniteur couleur avec affichage de fonction (OSD)
Dimension de l'écran	7" diagonal
Champ de vision	Haut: 85°, Bas: 85°, Gauche: 85°, Droite: 85°
Résolution	1024x3(RGB)x600
Image vidéo	Normal - miroir via OSD
Alimentation	12/24Vdc input
Entrées	3 x caméra
Dimensions	195,5(l) x 117,5(h) x 25,5(p)mm 7,6(l) x 4,6(h) x 1(p) pouces
Température d'utilisation	-30°C ~ +70°C -22°F ~ +158°F

DE Spezifikationen	
Monitor	VBV-770HM
TV-System	CVBS-NTSC/PAL AHD 1.0-720p/AHD 2.0-1080p (Automatische Erkennung)
Bild	7" TFT LCD Farbmonitor mit Funktionsanzeige (OSD)
Bildschirmgröße	7" diagonale
Sichtfeld	Oben: 85°, Unten: 85°, Links: 85°, Rechts: 85°
Auflösung	1024x3(RGB)x600
Videobild	Normal - Spiegelbild durch OSD
Stromversorgung	12/24Vdc Eingang
Eingänge	3 x Kamera
Abmessungen	195,5(b) x 117,5(h) x 25,5(t)mm 7,6(b) x 4,6(h) x 1(t) Zoll
Betriebstemperatur	-30°C ~ +70°C -22°F ~ +158°F

IT Specifiche	
Schermo	VBV-770HM
Sistema TV	CVBS-NTSC/PAL AHD 1.0-720p/AHD 2.0-1080p (rilevamento automatico)
Immagine	Display TFT LCD a colori da 7" con funzione OSD
Formato display	7" diagonale
Campo visivo	Alto: 85°, Basso: 85°, Sinistrato: 85°, Destra: 85°
Risoluzione	1024x3(RGB)x600
Immagine a video	Normale - Specchio via OSD
Alimentazione	12/24Vdc ingresso
Prese	3 x telecamera
Dimensioni	195,5(l) x 117,5(a) x 25,5(p)mm 7,6(l) x 4,6(a) x 1(p) pollici
Temperatura di servizio	-30°C ~ +70°C -22°F ~ +158°F

6 Specifications

Spécifications/Spesifikationer/Specifiche/Especificaciones/Specificaties/
Especificações/Спецификация/Özellikler/Specyfikacja

DE Especificaciones	
Monitor	VBV-770HM
Sistema de TV	CVBS-NTSC/PAL AHD 1.0-720p/AHD 2.0-1080p (Detección automática)
Imagen	Monitor a color de 7" TFT LCD con visualización de las funciones (OSD)
Tamaño de pantalla	7" diagonal
Campo visual	arriba: 85°, abajo: 85°, a la izquierda: 85°, a la derecha: 85°
Resolución	1024x3(RGB)x600
Imagen de vídeo	Normal - espejo a través de OSD
Suministro de corriente	12/24Vdc entrada
Entradas	3 x cámara
Dimensiones	195,5(a) x 117,5(a) x 25,5(p)mm 7,6(a) x 4,6(a) x 1(p) pulgadas
Temperatura de servicio	-30°C ~ +70°C -22°F ~ +158°F

PT Especificaciones	
Monitor	VBV-770HM
Sistema de TV	CVBS-NTSC/PAL AHD 1.0-720p/AHD 2.0-1080p (Auto detectar)
Imagen	Monitor a color de 7" TFT LCD con visualización de las funciones (OSD)
Tamanho da tela	7" diagonal
Campo visual	acima: 85°; abaixo: 85°; esquerda: 85°; direita: 85°
Resolução	1024x3(RGB)x600
Imagem de vídeo	Normal - espelhado via OSD
Potência	12/24Vdc entrada
Entradas	3 x cámara
Dimensões	195,5(l) x 117,5(a) x 25,5(p)mm 7,6(l) x 4,6(a) x 1(p) polegadas
Temperatura de operação	-30°C ~ +70°C -22°F ~ +158°F

NL Specificaties	
Monitor	VBV-770HM
TV-systeem	CVBS-NTSC/PAL AHD 1.0-720p/AHD 2.0-1080p (automatische detectie)
Beeld	7 "TFT LCD kleuren monitor met on-screen display functie
Displayformaat	7" diagonaal
Gezichtsveld	Boven: 85°, Onder: 85°, Links: 85°, Rechts: 85°
Resolutie	1024x3(RGB)x600
Videobeeld	Normaal - gespiegeld via OSD
Stroomvoorziening	12/24Vdc Ingang
Ingangen	3 x camera
Afmetingen	195,5(b) x 117,5(h) x 25,5(d)mm 7,6(b) x 4,6(h) x 1(d) inches
Bedrijfstemperatuur	-30°C ~ +70°C -22°F ~ +158°F

RU Спецификация	
монитор	VBV-770HM
ТВ-система	CVBS-NTSC/PAL AHD 1.0-720p/AHD 2.0-1080p (Автоматическое определение)
изображение	7 "TFT LCD цветной монитор с функцией индикации на экране
размер дисплея	7" диагональ
Угол обзора	топ: 85°, дно: 85°, слева: 85°, право: 85°
Разрешение	1024x3(RGB)x600
фото изображение	Нормальный - Зеркальный с помощью экранного меню
Напряжение	12/24Vdc затраты
затраты	3 x камеры
размеры	195,5(ш) x 117,5(в) x 25,5(г)mm 7,6(ш) x 4,6(в) x 1(г) дюймов
Рабочая температура	-30°C ~ +70°C -22°F ~ +158°F

6 Specifications

Spécifications/Spesifikationer/Specifiche/Especificaciones/Specificaties/
Especificações/Спецификация/Özellikler/Specyfikacja

PL Specyfikacja	
Monitor	VBV-770HM
System TV	CVBS-NTSC/PAL AHD 1.0-720p/AHD 2.0-1080p (Auto detect)
Obraz	Kolorowy monitor LCD 7" funkcja OSD
Wielkość wyświetlacza	7 " przekątnej
Pole Widzenia	Góra: 85°, dół: 85°, lewo: 85°, prawo: 85°
Rozdzielczość	1024x3(RGB)x600
Wyswietlany obraz	normalny lub obrócony lustrzany – ustawienia OSD
Zasilanie	12/24V Prąd Stały
Wejścia	3 x kamera
Wymiary	195.5(s) x 117.5(h) x 25.5(g)mm 7.6(s) x 4.6(h) x 1(g) cali
Zakres temperatur	-30°C ~ +70°C -22°F ~ +158°F

TR Özellikler	
Monitör	VBV-770HM
Tv Sistemi	CVBS-NTSC/PAL AHD 1.0-720p/AHD 2.0-1080p (otomatik seçim)
Görüntü	7" TFT LCD Renkli Monitör (Ekranla Kumanda Görüntü Fonksiyonlu)
Ekran Ebadı	7" (çapraz)
Görüntü Alanı	Üst: 85°, Alt: 85°, Sağ: 85°, Sol: 85°
Ekran Çözünürlüğü	1024x3(RGB)x600
Ekran Görüntüsü	Normal – OSD ile Ayna Görüntüsü
Güç	12/24 VDC besleme
Girişler	3 x Kamera Girişi
Ebatlar	195.5(g) x 117.5(y) x 25.5(d)mm 7.6(g) x 4.6(y) x 1(d) inç
Çalışma sıcaklığı	-30°C ~ +70°C -22°F ~ +158°F

Disclaimer

Camera monitor systems are an invaluable driver aid but do not exempt the driver from taking every normal precaution when conducting a manoeuvre. No liability arising out of the use or failure of the product can in any way be attached to Brigade or to the distributor.

Dénégation

Les systèmes de moniteurs des caméras sont une aide précieuse pour le conducteur, mais celui-ci doit toutefois prendre toutes les précautions nécessaires pendant les manœuvres. Brigade ou ses distributeurs n'assument aucune responsabilité résultant de l'utilisation ou d'un défaut du produit.

Haftungsausschluss

Kamera-Monitor-Systeme sind für den Fahrer eine unschätzbare Hilfe, ersetzen aber beim Manövrieren keinesfalls die üblichen Vorsichtsmaßnahmen. Für Schäden aufgrund der Verwendung oder eines Defekts dieses Produkts übernehmen Brigade oder der Vertriebshändler keinerlei Haftung.

Condizioni di Utilizzo

I sistemi di telecamere e monitor costituiscono un prezioso ausilio alla guida, ma il conducente deve comunque assicurarsi di prendere tutte le normali precauzioni quando esegue una manovra. Né Brigade né il suo distributore saranno responsabili per eventuali danni di qualsiasi natura causati dall'utilizzo o dal mancato utilizzo del prodotto.

Aviso legal

Aunque los sistemas de cámaras con pantalla constituyen una valiosa ayuda, no eximen al conductor de tomar todas las precauciones normales al hacer una maniobra. Brigade y sus distribuidores comerciales no se responsabilizan de cualquier daño derivado del uso o de un mal funcionamiento del producto.

Declinação de responsabilidade

Os sistemas de monitoria da câmara são uma ajuda inculculável ao motorista, mas não dispensam o motorista de tomar todas as precauções normais ao realizar uma manobra. Nenhuma responsabilidade decorrente do uso ou falha do produto pode de forma alguma ser atribuída ao Brigade ou ao distribuidor.

Specifications subject to change. Sous réserve de modifications techniques. Änderungen der technischen Daten vorbehalten. Specifiche soggette a variazioni. Las especificaciones están sujetas a cambios. Wijzigingen in specificaties voorbehouden. As especificações estão sujeitas a alterações. Спецификация может изменяться. Brigade Electronics belirttiği özellikleri haber vermeksizin istediği zaman değiştirebilir. Specyfikacja techniczna może ulec zmianie.



Verwerping

De camera-monitorsystemen zijn een waardevolle hulp voor de bestuurder, maar ontheffen hem echter niet van de verplichting om het voertuig zorgvuldig te manoeuvreren. Brigade en zijn distributeurs zijn niet aansprakelijk voor schade door gebruik of het niet functioneren van het product.

Отказ от обязательств

Системы камерного слежения являются крайне полезным средством помощи водителю, но не освобождают водителя от обязанности соблюдения всех необходимых мер предосторожности при совершении маневра. На компанию Brigade или распространителя продукции не налагается никакая ответственность, возникающая по причине использования или неисправности данного продукта.

Hatırlatma

Kamera Monitör Sistemleri sürücünün önemli bir yardımcısı olmakla birlikte, manevra esnasında sürücü bir kaza olmaması için her türlü önlemi almalıdır. Brigade veya bölgesel dağıtıcıları yapılacak yanlış bir uygulama ve sonucunda oluşabilecek maddi ve/veya manevi kayıplardan sorumlu tutulamaz.

Uwaga

Wizyjny system wspomagania cofania jest niezastapioną pomocą dla kierowcy, ale jego posiadanie nie zwalnia z zachowania szczególnej ostrożności podczas manewrów. Żadna kolizja drogowa ani jej skutki nie mogą obciążać producenta urządzenia oraz jego dystrybutorów.

Serial No:

Part No:

